

Article number: 20240843770GG

Description: E+G Telescope-Liאר motion bearings GN 2408-43-770-GG

Measures

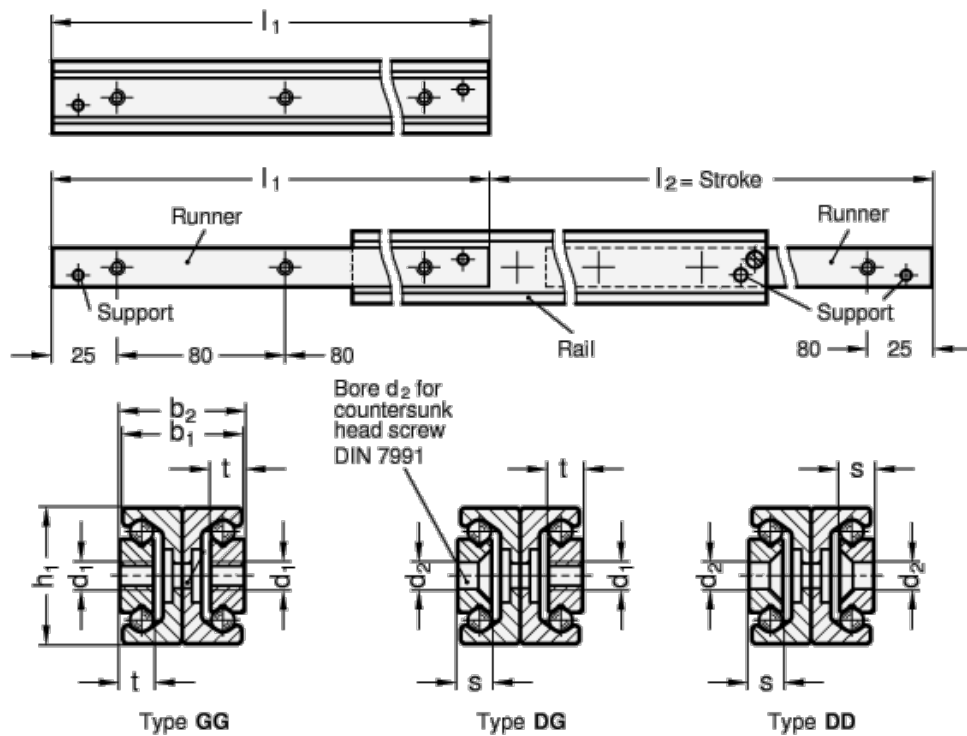

$b_1 = 42$
 $b_2 = 44$
 $d_1 = M8$
 $d_2 =$
 $h_1 = 43$
 $L_1 = 770 - 796$
 $s =$
 $t = 13.5$

Weight in (g) = 8090